

SIG2218

GENERATOR OPERATOR'S MANUAL

PLEASE READ THIS MANUAL CAREFULLY BEFORE OPERATION

MANUAL DEL OPERADOR DEL GENERADOR

LEA ESTE MANUAL ATENTAMENTE ANTES DE LA OPERACIÓN

MANUEL D'UTILISATION DU GÉNÉRATEUR

VEUILLEZ LIRE ATTENTIVEMENT CE MANUEL AVANT L'UTILISATION

⚠ DANGER



DEADLY EXHAUST FUMES! ONLY use OUTSIDE far away from windows, doors and vents!



NOT INTENDED FOR USE IN CRITICAL LIFE SUPPORT APPLICATIONS.



SAVE this Manual. Provide this manual to any operator of the generator.



⚠ WARNING

This product and its exhaust can expose you to chemicals including lead and lead compounds, and carbon monoxide, which are known to the State of California to cause cancer and birth defects or other reproductive harm. For more information go to www.P65Warnings.ca.gov.

This Manual contains important safety information and instructions for operating this generating set. **PLEASE READ THIS MANUAL CAREFULLY.** Failure to do so could result in property damage and/or personal INJURY/DEATH.

Provide this manual to any operator of this generator. This manual should be considered as a permanent part of your generator and should remain with it when you sell it.

The pictures and figures in the manual shall be only for reference. There may be differences between the pictures and figures and the physical product.

Table of contents

Operator Safety.....	2
Safety Rules.....	2
Getting Started.....	5
Know the Generator.....	6
Features and Controls.....	9
Operating.....	9
Operating Checklist.....	9
High Altitude.....	9
Operating Condition.....	9
Engine Oil.....	9
Engine Fuel.....	10
Electrical Devices.....	11
Grounding.....	11
Starting the Generator.....	11
Connect to Electrical Devices.....	12
Stopping the Engine.....	13
Parallel Operation (If applicable).....	13
Maintenance.....	14
Maintenance Schedule.....	14
Generator Maintenance.....	15
Engine Maintenance.....	15
Engine Oil.....	15
Add Oil.....	15
Change Oil.....	15
Spark Plug.....	15
Spark Arrester.....	16
Air Filter.....	16
Trouble Analysis and Troubleshooting.....	17
Storage and Transportation.....	17
Storage.....	17
Transportation.....	17
Specification.....	18
Specification Parameter Table.....	18
Wiring Diagram for 60Hz.....	19
Limited Warranty.....	20

SAVE THESE INSTRUCTIONS FOR FUTURE USE

All information in this publication is based on the latest product information available at the time of printing. We reserve the right to change, alter and/or improve the product and this document at any time without notice and without incurring any obligation.

Write down the serial number and purchase information of the generator. Keep this manual and the receipt for future reference.

Model: _____

Serial number: _____

Date of purchase: _____

OPERATOR SAFETY

Safety Rules



Pay attention to this safety alert symbol. Obey all safety messages that follow this symbol to avoid possible property damage, INJURY or DEATH. Each safety message is preceded by a safety alert symbol and one of three words, DANGER, WARNING, or CAUTION.

⚠ DANGER

Indicates a hazardous situation that, if not strictly complied with, will result in substantial property damage, serious injury or DEATH.

⚠ WARNING

Indicates a hazardous situation that, if not strictly complied with, may result in property damage, serious injury or DEATH.

⚠ CAUTION

Indicates a hazardous situation that, if not strictly complied with, could result in property damage or injury.



⚠ WARNING

READ THIS MANUAL COMPLETELY BEFORE OPERATING.

DO NOT operate this generator until you have read ALL safety, operation, and maintenance Instructions listed in this manual.

Failure to follow the instructions may result in property damage, INJURY or DEATH.

The warnings and precautions discussed in this manual cannot cover all possible conditions and situations that may occur. It must be understood by the operator that common sense and caution are factors which cannot be built into this product, but must be possessed by the operator.

⚠ WARNING

This generator is intended for residential consumer use only. DO NOT modify the engine and DO NOT use the engine for a purpose for which it is not intended.



⚠ WARNING

KICKBACK

Rapid retraction of the starter cord will pull your hand and arm towards the generator faster than you can let go.

Accidental starts can result in entanglement, traumatic amputation or laceration.

Broken bones, fractures, bruises or sprains could result.

⚠ WARNING:

Before each use, check for loose or damaged parts, signs of oil or fuel leaks, and any other condition that may affect proper operation. Repair or replace all damaged or defective parts immediately.

Locate all operating controls and safety labels.

Keep all safety guards in place and in proper working order at all times.

DO NOT allow any material to block the cooling slots.

DO NOT allow children or untrained persons to operate the generating set.

DO NOT run the generator unattended. Turn off the generator before leaving the area.



⚠ WARNING:

FIRE

Operation of this generator may create sparks that can start fires around dry vegetation.

This generator may not be equipped with a spark arresting muffler. If the generator will be used around flammable materials, or on land covered with materials such as agricultural crops, forest, brush, grass, or other similar items, then an approved spark arrester must be installed.

In some area, a spark arrester is required by law. Please contact local fire agencies for laws or regulations relating to fire prevention requirements.

⚠ WARNING:

Read the instructions provided with the equipment that is powered by this engine for any additional safety rules that should be observed in conjunction with generator startup, shutdown, operation, or protective apparel that may be needed to operate the equipment.



⚠ WARNING:

HOT SURFACE

The running generator produces heat. Severe burns can occur on contact.

DO NOT touch generator while operating or just after stopping. Avoid contact with hot exhaust gases.

Maintain at least three feet of clearance on all sides to ensure adequate cooling.

Combustible material can catch fire on contact. Maintain at least five feet of clearance from combustible materials.



⚠ DANGER:

TOXIC FUMES

The exhaust of the engine contains carbon monoxide, an odorless, colorless, poison gas. Using engine indoors CAN KILL YOU!

NEVER use inside any building or any kind of enclosure, EVEN IF doors and windows are open.

Place the generator in a well ventilated area and carefully consider wind and air currents when positioning the generator.



⚠ DANGER:

FIRE OR EXPLOSION

Gasoline is highly flammable and extremely explosive.

Fire or explosion can cause severe burns or death.

Keep flammable items away while handling gasoline.

Fill fuel tank outdoors and in a well-ventilated area with the generator stopped.

Always wipe off spilled fuel and wait until the fuel has dried before starting the generator.

DO NOT operate the generator with known leaks in the fuel system.

Use proper fuel storage and handling procedures. DO NOT store fuel or other flammable materials nearby.

Empty the fuel tank before storing or transporting this generator.

Keep fire extinguisher handy and be prepared if a fire starts.



⚠ DANGER:

MOVING PARTS

Moving parts can cause severe injury. Keep hands and feet away.

DO NOT operate generator with covers, shrouds, or guards removed.

DO NOT wear loose-fitting clothing, dangling drawstrings or items that could become caught. Tie up long hair and remove jewelry.

NEVER place fingers, hands, or body near the generator when it is running period.

⚠ WARNING:

ACID

(For types equipped with battery)

Be careful when using any battery.

Keep away from open flames, heat or spark.

Battery will exhaust hydrogen while charging. Only charge a battery in a well ventilated place.

Avoid spilled battery acid. If contact with skin is made, wash immediately with clean water.

GENERAL HAZARDS



- NEVER operate in an enclosed area, in a vehicle, or indoors EVEN IF doors and windows are open.
- For safety reasons, the manufacturer recommends that the maintenance of this equipment is carried out by an Authorized Dealer. Inspect the generator regularly, and contact the nearest Authorized Dealer for parts needing repair or replacement.
- Operate generator only on level surfaces and where it will not be exposed to excessive moisture, dirt, dust or corrosive vapors.
- Keep hands, feet, clothing, etc., away from drive belts, fans, and other moving parts. Never remove any fan guard or shield while the unit is operating.
- Certain parts of the generator get extremely hot during operation. Keep clear of the generator until it has cooled to avoid severe burns.
- DO NOT operate generator in the rain.
- DO NOT alter the construction of the generator or change controls which might create an unsafe operating condition.
- Never start or stop the unit with electrical loads connected to receptacles AND with connected devices turned ON. Start the engine and let it stabilize before connecting electrical loads. Disconnect all electrical loads before shutting down the generator.
- DO NOT insert objects through unit's cooling slots.
- When working on this equipment when physically or mentally fatigued.
- Never use the generator or any of its parts as a step. Stepping on the unit can stress and break parts, and may result in dangerous operating conditions from leaking exhaust gases, fuel, oil, etc.

NOTE:

This generator may be equipped with a spark arrestor muffler. The spark arrestor must be maintained in effective working order by the owner/operator. In the State of California, a spark arrestor is required by law (Section 4442 of the California Public Resources Code). Other states may have similar laws. Federal laws apply on federal lands.

EXHAUST & LOCATION HAZARDS

- NEVER operate in an enclosed area or indoors! NEVER use in the home, in a vehicle, or in partly enclosed areas such as garages, EVEN IF doors and windows are open! ONLY use outdoors and far from open windows, doors, vents, and in an area that will not accumulate deadly exhaust.

 DANGER	
Using a generator indoors CAN KILL YOU IN MINUTES. Generator exhaust contains carbon monoxide. This is a poison you cannot see or smell.	
 NEVER use inside a home or garage, EVEN IF doors and windows are open.	 Only use OUTSIDE and far away from windows, doors, and vents.

- The engine exhaust fumes contain carbon monoxide, which you cannot see or smell. This poisonous gas, if breathed in sufficient concentrations, can cause unconsciousness or even **death**.
- Adequate, unobstructed flow of cooling and ventilating air is critical to correct generator operation. Do not alter the installation or permit even partial blockage of ventilation provisions, as this can seriously affect safe operation of the generator. The generator **MUST** be operated outdoors.

- This exhaust system must be properly maintained. Do nothing that might render the exhaust system unsafe or in noncompliance with any local codes and/or standards.
- Always use a battery operated carbon monoxide alarm indoors, installed according to the manufacturer's instructions.
- If you start to feel sick, dizzy, or weak after the generator has been running, move to fresh air **IMMEDIATELY**. See a doctor, as you could have carbon monoxide poisoning.

ELECTRICAL HAZARDS

- The generator produces dangerously high voltage when in operation. Avoid contact with bare wires, terminals, connections, etc., while the unit is running, even on equipment connected to the generator. Ensure all appropriate covers, guards and barriers are in place before operating the generator.
- Never handle any kind of electrical cord or device while standing in water, while barefoot or while hands or feet are wet. **DANGEROUS ELECTRICAL SHOCK MAY RESULT.**
- The National Electric Code (NEC) requires the frame and external electrically conductive parts of the generator be properly connected to an approved earth ground. Local electrical codes may also require proper grounding of the generator. Consult with a local electrician for grounding requirements in the area.
- Use a ground fault circuit interrupter in any damp or highly conductive area (such as metal decking or steel work).
- Do not use worn, bare, frayed or otherwise damaged electrical cord set with the generator.
- Before performing any maintenance on the generator, disconnect the engine starting battery (if equipped) to prevent accidental start up. Disconnect the cable from the battery post indicated by a NEGATIVE, NEG or (-) first. Reconnect that cable last.
- In case of accident caused by electric shock, immediately shut down the source of electrical power. If this is not possible, attempt to free the victim from the live conductor. **AVOID DIRECT CONTACT WITH THE VICTIM.** Use a non-conducting implement, such as a rope or board, to free the victim from the live conductor. If the victim is unconscious, apply first aid and get immediate medical help.

FIRE HAZARDS

- Gasoline is highly **FLAMMABLE** and its vapors are **EXPLOSIVE**. Never permit smoking, open flames, sparks or heat in the vicinity while handling gasoline.
- Never add fuel while unit is running or hot. Allow engine to cool completely before adding fuel.
- **Never fill fuel tank indoors.** Comply with all laws regulating storage and handling of gasoline.
- **Do not overfill the fuel tank. Always allow room for fuel expansion.** If tank is over-filled, fuel can overflow onto a hot engine and cause FIRE or an EXPLOSION. Never store generator with fuel in tank where gasoline vapors might reach an open flame, spark or pilot light (as on a furnace, water heater or clothes dryer). FIRE or EXPLOSION may result. Allow unit to cool entirely before storage.
- Wipe up any fuel or oil spills immediately. Ensure that no combustible materials are left on or near the generator. Keep the area surrounding the generator clean and free from debris and keep a clearance of five (5) feet on all side to allow for proper ventilation of the generator.
- Do not insert objects through unit's cooling slots.
- **Never** operate the generator if connected electrical devices overheat, if electrical output is lost, if engine or generator sparks or if flames or smoke are observed while unit is running.
- Keep a fire extinguisher near the generator at all times.

STANDARDS INDEX

1. National Fire Protection Association (NFPA) 70: The NATIONAL ELECTRIC CODE (NEC) available from www.nfpa.org
2. National Fire Protection Association (NFPA) 5000: BUILDING CONSTRUCTION AND SAFETY CODE available from www.nfpa.org
3. International Building Code available from www.iccsafe.org
4. Agricultural Wiring Handbook available from www.nerc.org , Rural Electricity Resource Council P.O. Box 309 Wilmington, OH 45177-0309
5. ASAE EP-364.2 Installation and Maintenance of Farm Standby Electric Power available from www.asabe.org, American Society of Agricultural & Biological Engineers 2950 Niles Road, St. Joseph, MI 49085

This list is not all inclusive. Check with the Authority Having Local Jurisdiction (AHJ) for any local codes or standards which may be applicable to your jurisdiction.

MODEL NO:	
SERIAL NO:	

Unit ID location

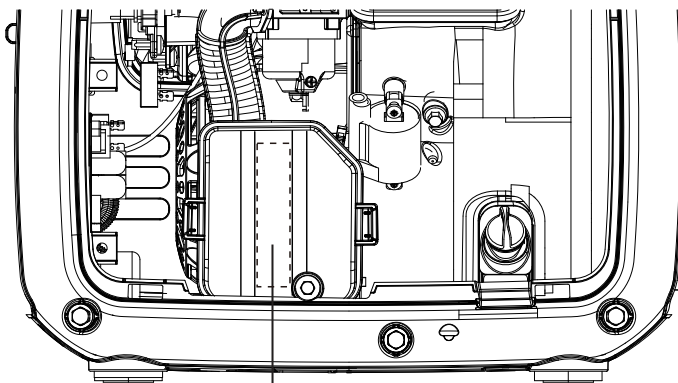

MODEL DATA DECAL

GETTING STARTED

Unpacking

Remove the generator from the shipping carton

- Place the shipping carton on a solid, flat surface.
- Carefully cut each corner of the carton box from top to bottom. Fold each side flat on the ground.
- Remove everything from the carton except the generator.

Emission Information

The Environmental Protection Agency (and California Air Resource Board for generators certified to CA standards) requires that this generator comply with exhaust and evaporative emission standards. Locate the emissions compliance decal on the engine to determine what standards the generator meets, and to determine which warranty applies. This generator is certified to operate on gasoline. The emission control system includes the following components (if equipped):

- Air Induction System
 - Intake Pipe / Manifold
 - Air Cleaner
- Fuel System
 - Carburetor
 - Fuel Tank / Cap
 - Fuel Lines
 - Evaporative Vent Lines
 - Carbon Canister
- Ignition System
 - Spark Plug
 - Ignition Module
- Exhaust System
 - Exhaust Manifold
 - Muffler
 - Pulsed Air Valve
 - Catalyst

Optional Accessories

Since accessories, other than those offered by SIMPSON, have not been tested with this product, use of such accessories with this tool could be hazardous. To reduce the risk of injury, only SIMPSON recommended accessories should be used with this product.

Consult your dealer for further information on the appropriate accessories. If you need assistance in locating any accessory for your tool, please contact Customer Support at 1-877-362-4271 .

KNOW THE GENERATOR

Read the Owner's Manual and Safety Rules before operating this generator.

Compare the generator to the following figure to become familiarized with the locations of various controls and adjustments. Save this manual for future reference.

Control Panel

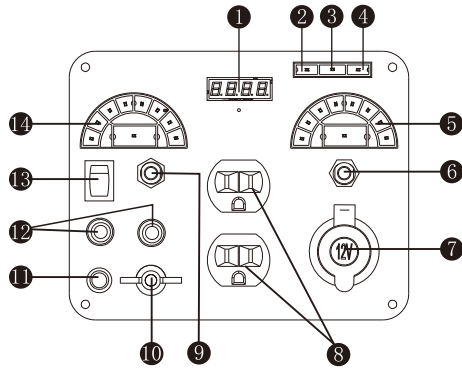

- | | |
|----------------------|------------------------|
| ① Hourmeter | ⑧ Duplex Receptacle |
| ② Running indicator | ⑨ AC circuit breaker |
| ③ Overload indicator | ⑩ Ground terminal |
| ④ Low oil indicator | ⑪ Reset button |
| ⑤ Power display | ⑫ Parallel Ports |
| ⑥ DC circuit breaker | ⑬ Energy-saving switch |
| ⑦ DC output, 12V | ⑭ Fuel display |

Running indicator (green)

The running indicator lights up when generator starts and has normal output.

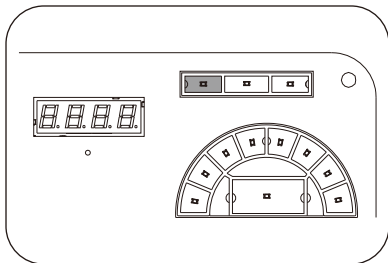

Overload indicator (red)

When the overload indicator is on, it indicates that the generator has stopped output to protect the electrical equipment and the generator itself. At this time, the running indicator (green) is off and the overload indicator (red) is on, but the engine is still in running state.

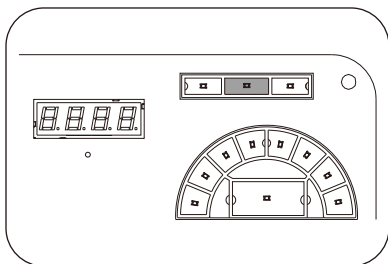

When the generator has no output and the overload indicator is on, please take the following steps:

1. Lower the total power of the connected electric devices to the rated output range of generator.
2. Check the air intake for impurities and check the control parts for abnormal situation. Handle immediately if necessary.
3. Restart after checking.

Low oil indicator (yellow)

When the oil level drops below the limit, the oil protection system will stop the engine automatically and the low oil indicator will blink. The engine will not run until the oil has been filled to the proper level.

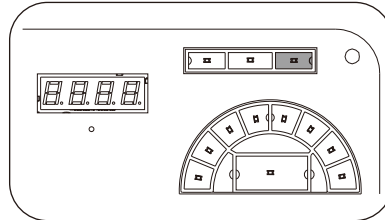

Note: If the low oil indicator lights up, it indicates lack of oil. Please add appropriate oil and restart the engine.

Hourmeter

The hourmeter tracks the accumulated running hours of generator.

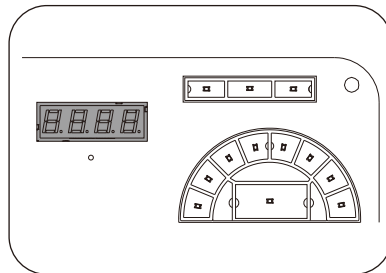

Fuel display

The fuel display indicates the fuel level in the fuel tank.

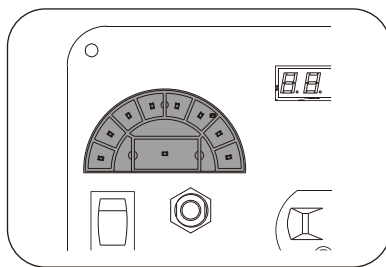

Power display

The power display indicates the power of the running generator.

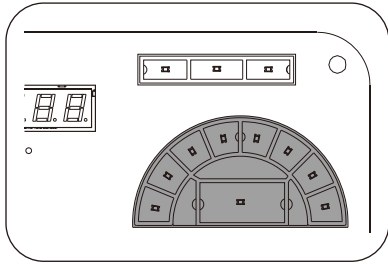

Energy-saving switch

When the energy-saving (eco-mode) switch is in "ON" position, the energy saving equipment controls the engine rotate speed according to the connected loads. There will be good fuel consumption and low noise. When the energy-saving switch is in "OFF" position, the engine will always run in rated rotate speed no matter it is connected to the loads or not

Note: Please set the energy-saving switch (Eco-mode) to the "OFF" position when connecting to an air compressor, sump pump, etc. This type of equipment requires a large amount of starting current.

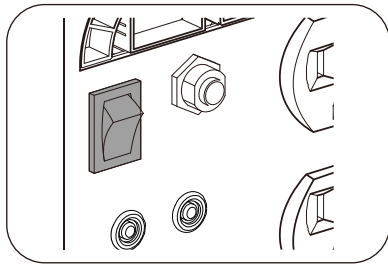

Grounding terminal

The grounding terminal is designed to prevent electric shock by connecting it to the grounding wire. The generator must be properly grounded before operation.

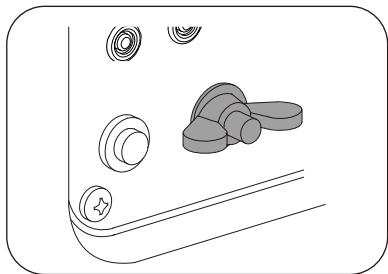

Reset button

The reset button is used to restore output if an overload occurs. To restore output, reduce the load and press the reset button.

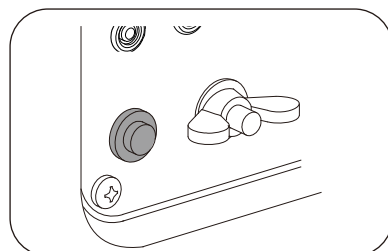

AC&DC Circuit breaker

The circuit breaker protects the generator against electrical overload.

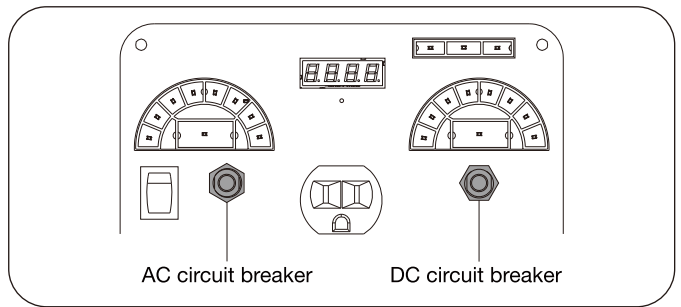

CHOKE/RUN/OFF Dial

The dial is used to start and stop the generator. Turn the dial to the CHOKE position and pull the recoil starter to start the generator. Turn the dial to the RUN position after generator is started. Turn the dial to the OFF position to stop generator.

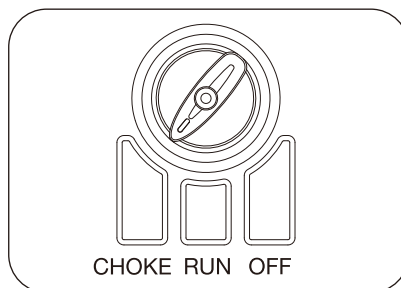

Fuel tank cap

Remove the fuel tank cap by rotating it counterclockwise.

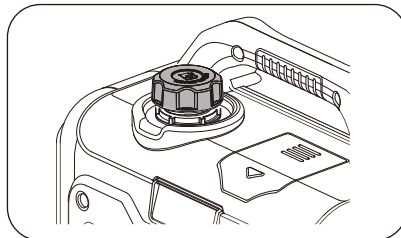

⚠ DANGER:



Never operate in an enclosed area or indoors! NEVER use in the home, in a vehicle, or in partly enclosed areas such as garages, EVEN IF doors and windows are open! ONLY use outdoors and far from open windows, doors, vents, and in an area that will not accumulate deadly exhaust.



The engine exhaust fumes contain carbon monoxide, which you cannot see or smell. This poisonous gas, if breathed in sufficient concentrations, can cause unconsciousness or even death.



Adequate, unobstructed flow of cooling and ventilating air is critical to correct generator operation. Do not alter the installation or permit even partial blockage of ventilation provisions, as this can seriously affect safe operation of the generator. The generator MUST be operated outdoors.



This exhaust system must be properly maintained. Do nothing that might render the exhaust system unsafe or in noncompliance with any local codes and/or standards.



Always use a battery operated carbon monoxide alarm indoors, installed according to the manufacturer's instructions.

⚠ DANGER

Using a generator indoors CAN KILL YOU IN MINUTES. Generator exhaust contains carbon monoxide. This is a poison you cannot see or smell.

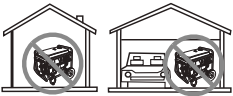

NEVER use inside a home or garage, EVEN IF doors and windows are open.



Only use OUTSIDE and far away from windows, doors, and vents.

Grounding the generator when used as a portable

This generator has an equipment ground that connects the generator frame components to the ground terminals on the AC output receptacles (see NEC 250.34 (A) for explanation). This allows the generator to be used as a portable without grounding the frame of the generator as specified in NEC 250.34.

Special Requirements

There may be Federal or State Occupational Safety and Health Administration (OSHA) regulations, local codes, or ordinances that apply to the intended use of the generator.

Please consult a qualified electrician, electrical inspector, or the local agency having jurisdiction:

- In some areas, generators are required to be registered with local utility companies.
- If the generator is used at a construction site, there may be additional regulations which must be observed.

Connecting the generator to a building's electrical system

When connecting directly to a building's electrical system, it is recommended that a manual transfer switch is used. Connections for a portable generator to a building's electrical system must be made by a qualified electrician and in strict compliance with all national and local electrical codes and laws.

WATTAGE REFERENCE GUIDE

Device	Running Watts
*Air Conditioner (12,000 Btu)	1700
*Air Conditioner (24,000 Btu)	3800
*Air Conditioner (40,000 Btu)	6000
Battery Charger (20 Amp)	500
Belt Sander (3")	1000
Chain Saw	1200
Circular Saw (6-1/2")	800 to 1000
*Clothes Dryer (Electric)	5750
*Clothes Dryer (Gas)	700
*Clothes Washer	1150
Coffee Maker	1750
*Compressor (1 HP)	2000
*Compressor (3/4 HP)	1800
*Compressor (1/2 HP)	1400
Curling Iron	700
*Dehumidifier	650
Disc Sander (9")	1200
Edge Trimmer	500
Electric Blanket	400
Electric Nail Gun	1200
Electric Range (per element)	1500
Electric Skillet	1250
*Freezer	700
*Furnace Fan (3/5 HP)	875
*Garage Door Opener	500 to 750
Hair Dryer	1200
Hand Drill	250 to 1100
Hedge Trimmer	450
Impact Wrench	500
Iron	1200
*Jet Pump	800
Lawn Mower	1200
Light Bulb	100
Microwave Oven	700 to 1000
*Milk Cooler	1100
Oil Burner on Furnace	300
Oil Fired Space Heater (140,000 Btu)	400
Oil Fired Space Heater (85,000 Btu)	225
Oil Fired Space Heater (30,000 Btu)	150
*Paint Sprayer, Airless (1/3 HP)	600
Paint Sprayer, Airless (handheld)	150
Radio	50 to 200
*Refrigerator	700
Slow Cooker	200
*Submersible Pump (1-1/2 HP)	2800
*Submersible Pump (1 HP)	2000
*Submersible Pump (1/2 HP)	1500
*Sump Pump	800 to 1050
*Table Saw (10")	1750 to 2000
Television	200 to 500
Toaster	1000 to 1650
Weed Trimmer	500

* Allow 3 times the listed watts for starting these devices.

FEATURES AND CONTROLS

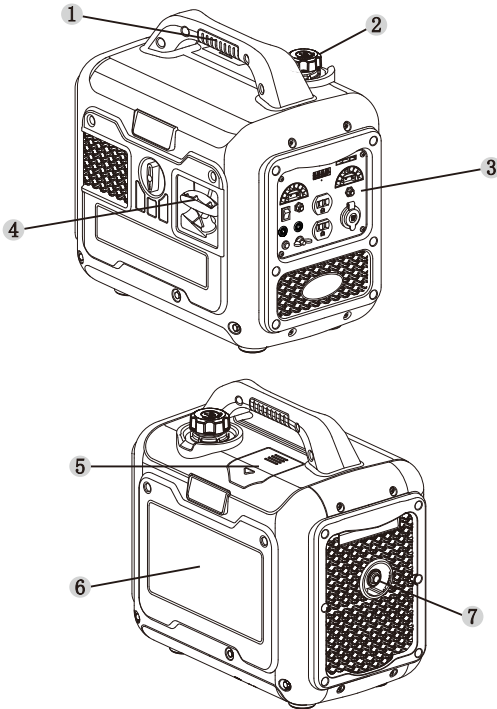

- | | |
|--------------------------------|----------------------------|
| 1 Carrying handle | 6 Maintenance access cover |
| 2 Fuel tank cap | 7 Muffler |
| 3 Control panel | |
| 4 Recoil starter | |
| 5 Spark plug maintenance cover | |

OPERATING

Operating Checklist

Operating Location

- Only use OUTSIDE and place the generator in a well-ventilated area and carefully consider wind and air currents. Never operate your generator outdoors during rain, snow or any combination of weather conditions that could lead to moisture collecting on or in the generator.
- Place the generator on a level surface before any operation. Always operate the generator on a dry surface free of any moisture.
- Generator must be at least 6 feet from any building, other equipment, or combustible material. Generator must not be located near any windows, doors, or vents.



⚠ DANGER:

TOXIC FUMES

The exhaust of the generator contains carbon monoxide, an odorless, colorless, poison gas. Using the generator indoors CAN KILL YOU!

NEVER use inside any building or any kind of enclosure, EVEN IF doors and windows are open.

Place the generator in a well-ventilated area and carefully consider wind and air currents when positioning generator.

High Altitude

This engine will have proper engine performance and emission control when it is operated at or below an altitude of 5000 feet (1524 meters). This engine requires a high-altitude carburetor kit to ensure proper engine performance and emission control when it is operated at altitudes above 5000 feet (1524 meters). Operating the engine with the wrong engine configuration above 5000 feet (1524 meters) may increase its emissions and decrease fuel efficiency and performance. To obtain a high-altitude carburetor kit, contact Customer Support.

⚠ CAUTION:

Operation of the engine with a high-altitude carburetor kit at an altitude below 1524 meters may cause the engine to overheat and result in serious engine damage.

Operating Condition

- Check for loose or damaged parts, signs of oil or fuel leaks, and any other condition that may affect proper operation.
- Repair or replace all damaged or defective parts immediately.

⚠ WARNING:

Failing to correct problem(s) before operation could result in property damage, serious injury or DEATH.

- Check the air filter. A dirty air filter will restrict air flow to the carburetor, reducing engine performance.
- Remove any excessive dirt or debris, especially around the muffler and recoil starter.
- DO NOT move or tip the generator during operation.
- Use generator only for intended uses. If you have questions about intended use contact Customer Support.

Engine oil

- Place the generator on a level surface with it stopped.
- Remove the Maintenance access cover.

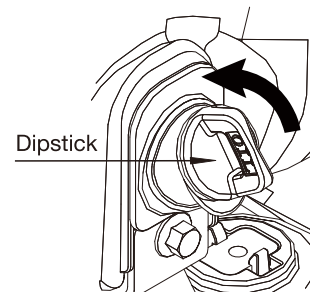
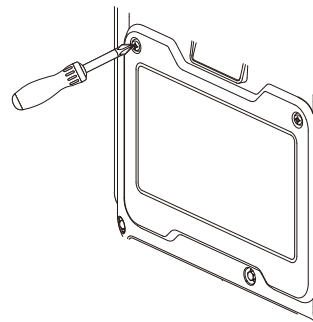

- Reinstall dipstick into hole; rest on oil fill neck, DO NOT thread cap into hole.
- Remove the dipstick again and check oil level. Level should be between the upper and lower limit.

- Fill to the upper limit of the dipstick with the recommended oil if the oil level is low.

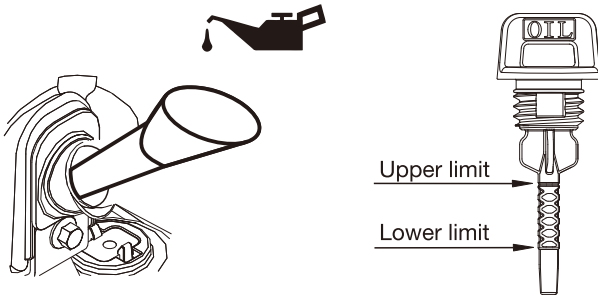

- Reinstall and fully tighten the dipstick.
- Engine damage could result from insufficient lubrication. Refer to **Add Oil** instruction in **MAINTENANCE** section for more information.
- See **SPECIFICATIONS** for oil capacity (rated).

⚠ WARNING:

This engine is not filled with oil at the factory. Any attempt to crank or start the engine before it has been properly filled with the recommended type and amount of oil may result in engine damage and void your warranty.

⚠ WARNING:

Oil is a major factor affecting performance and service life. Use 4-stroke automotive detergent oil recommended in the **MAINTENANCE** section of this manual.

⚠ WARNING:

Operate generator only on level surfaces. The low oil sensor (if equipped) will automatically stop the engine when the oil level falls below the safe limit. To avoid the inconvenient of an unexpected shutdown, fill to the upper limit and check the oil level regularly.

Engine fuel

- With the engine stopped, check the fuel level gauge. Refill the fuel tank if necessary.

⚠ CAUTION:

Pressure can build in the fuel tank. Allow the engine to cool for at least two minutes before removing fuel cap. Loosen the fuel cap slowly to relieve any pressure in the tanks.

- Use clean, fresh, unleaded gasoline with a minimum octane rating of 87. DO NOT mix oil with petrol gasoline or use gasoline older than 30 days. DO NOT use gasoline that contains more than 10% ethyl alcohol. E15, E20 and E85 are NOT approved fuels and should NOT be used.
- Be sure not to fill the fuel tank above the upper limit mark. Always allow room for fuel expansion.
- See **SPECIFICATIONS** for fuel capacity (rated).

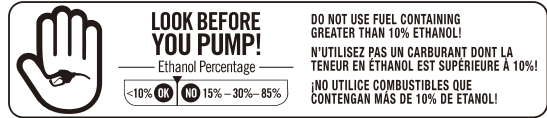

IMPORTANT: Ethanol Shield™ (sold separately) is a fuel stabilizer that helps eliminate and prevent ethanol related problems in power equipment. Follow the instructions on the container and add to the gasoline.

— Ethanol Percentage — **NOTICE:** Use of fuels with greater than 10% ethanol are not approved for use in this product per EPA regulations and will damage the unit and void the warranty.



MAXIMUM fuel adding position

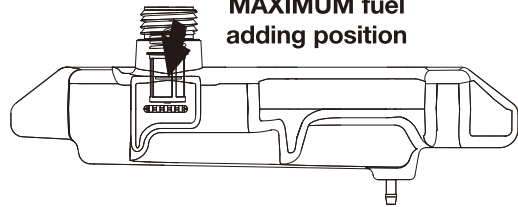

⚠ WARNING:

Do not fill the fuel tank above the maximum fuel level. Over fill will result in engine die or damage the carbon canister (if equipped) and void your warranty.



⚠ DANGER:

FIRE OR EXPLOSION

Gasoline is highly flammable and extremely explosive. Fire or explosion can cause severe burns or death. Keep flammable items away while handling gasoline. Fill fuel tank outdoors and in a well-ventilated area with the engine stopped. Always wipe off spilled fuel and wait until the fuel has dried before starting the engine. DO NOT operate the engine with known leaks in the fuel system. Use proper fuel storage and handling procedures. DO NOT store fuel or other flammable materials nearby. Empty the fuel tank before storing or transporting this engine. Keep fire extinguisher handy and be prepared if a fire starts.

NEVER use engine or carburetor cleaner products in the fuel tank or permanent damage may occur.

It is important to prevent gum deposits from forming in essential fuel system parts, such as the carburetor, fuel filter, fuel hose or tank during storage. Also, experience indicates that alcohol-blended fuels (called gasohol, ethanol or methanol) can attract moisture, which leads to separation and formation of acids during storage.

Acidic fuel can damage the fuel system of an engine while in storage. Be sure to review the instructions given in "Storage" section.

Gasoline/Alcohol Blends: up to 10% alcohol, 90% unleaded gasoline by volume is approved as a fuel. Other gasoline/alcohol blends are not approved. Effects of old, stale or contaminated fuel are not warrantable.

⚠ CAUTION:

To minimize gum deposits in your fuel system and to insure easy starting, do not use gasoline left over from the previous season.

⚠ CAUTION:

Pressure can build up in the fuel tank. Allow the generator to cool for at least two minutes before removing fuel cap. Loosen the fuel cap slowly to relieve any pressure in the tank.

Electrical devices

- Disconnect all electrical devices from the generator and switch off the circuit breaker before starting the engine.
- The generator may be hard to start with electrical devices connected.
- **The power of connected electrical devices can not over the limit of generator max power, see parameter sheet for reference.**

Grounding

- The generator must be properly connected to an appropriate ground. It helps prevent electrical shock if a ground fault condition exists in the generator or in connected electrical devices, especially with a wheel kit. Proper grounding also helps dissipate static electricity, which often builds up in ungrounded devices.

⚠ DANGER:

Electric Shock

Failure to properly ground the generator can result in electric shock.

- A ground terminal has been provided on the generator. For remote grounding, connect of a length of heavy gauge (4mm²) copper wire between the generator ground terminal and a copper rod driven into the ground.
- The National Electrical Code requires that the frame and external electrically conductive parts of this generator be properly connected to an approved earth ground. Local electrical codes may also require proper grounding of the unit. We strongly recommend that you consult with a qualified electrician for grounding requirements in your area.

Starting the generator

1. Perform **OPERATING CHECKLIST** (Page 9).
2. Turn the ON/OFF dial to the **CHOKE** position.

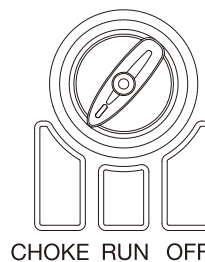

3. Turn the energy saving switch to the "ON" position. (Note: Please set the energy-saving switch to "OFF" position when it needs large starting current.)

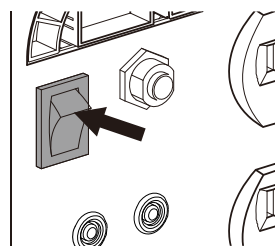

4. Manual start:

⚠ CAUTION:

Check starter cord conditions before operating. Have it replaced immediately by local authorized dealer if cord is frayed.

- When starting engine, grasp the recoil starter handle and pull slowly until resistance is felt. Then pull rapidly to avoid kickback. When pulling the recoil starter, firmly grasp the carrying handle to avoid tumble of generator.

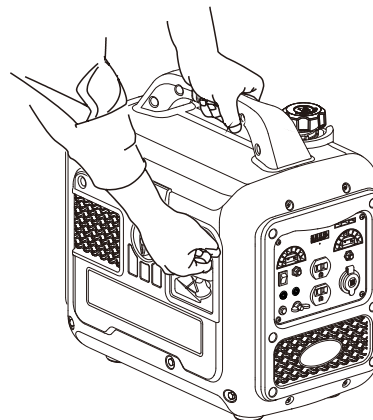

5. After the generator starts, turn the ON/OFF dial to the RUN position.

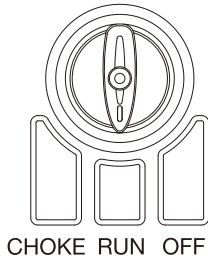

⚠ CAUTION:

Choke position for starting may vary depending upon temperature and other factors. If re-starting a warm engine, the choke should be left in the **HALF** or **CLOSE** position.



⚠ WARNING:

Kickback

Rapid retraction of the starter cord will pull hand and arm towards the engine faster than you can let go.

Unintentional startup can result in entanglement, traumatic amputation or laceration. Broken bones, fractures, bruises or sprains could result.

- If the starter fails to start the engine, immediately turn off the starter. Don't attempt to restart the engine before the failure cause is identified. Don't restart the engine by replacement of other storage battery without authorization.

⚠ WARNING:

The engine starts time cannot exceed 15 minutes. If the engine fails to start, allow the starting motor to cool for one minute before restart. Failure to operate according to this rule will damage the starting motor.

⚠ CAUTION:

If the engine fails to start after attempt for 3 times or flames out after starting, inspect and ensure that the generator is placed in horizontal surface and enough engine oil is included.

During starting, don't keep the starting switch to "start" position for more than 5 seconds, otherwise it is possible to damage the starter motor. If the unit fails to start within first time, restart after about 10 seconds. After the unit is used for a period, if the starting speed of the motor falls, please replace the storage battery.

During the operation of the unit, the storage battery supplies power for the solenoid valve of the carburetor. For this, when the unit is turned off, make sure that the starting switch is in "**OFF**" position and otherwise the storage battery voltage is reduced due to the operating solenoid valve of the carburetor, impacting on starting for next time.

If the engine is equipped with an engine oil alarm, it is possible to prevent engine start when the engine oil in the crankcase is lower than minimum level.

During running-in, routinely inspect the engine oil. See Maintenance section for recommended maintenance period.

- If the engine speed is raised to the speed over the starter but does not keep running (fails to start), then the engine must be completely stopped before starting again. If when the flywheel starts to rotate automatically, the starter is still engaged, then there may be a conflict between the flywheel external gear and the starter pinions, and this may cause damage to the starter.

⚠ CAUTION:

If the generator is in warm state, turn the ON/OFF dial to the RUN position when restart the generator.

6. After all above operations, the engine can be normally loaded.

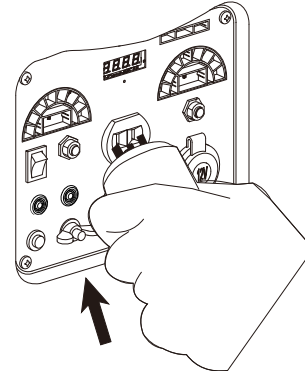

⚠ WARNING:

It is prohibited to start or close the generator when the output terminal of generator is connected to an electric device and the electric device is in "**ON**" state.

Connect to electrical devices

Inspect power cord for damage before using. There is a hazard of electric shock from crushing, cutting or heat damage.

- Inspect power cord for damage before using. There is a hazard of electrical shock from crushing, cutting or heat damage.
- Make sure that the generator has been properly grounded. If the electric devices require grounding, the generator must ground.
- Allow the engine to stabilize and warm up for a few minutes after starting.
- Make sure that the electric devices are in "OFF" position.
- Connect and start the electric devices.
- Turn off all electric devices and disconnect them from the generator.
- If the generator supplies for several loads or electric devices, start the smallest one first and the largest one last.

⚠ CAUTION:

If connected devices overheat, turn them off and disconnect them from generator.



⚠ DANGER:

Electric Shock

To reduce the risk of electrical shock, DO NOT use electrical cords that are worn, frayed, bare or otherwise damaged.

DO NOT touch bare wires of receptacles.

DO NOT handle generating set or electrical cords while standing in water, while barefoot, while hand or feet are wet.

Bearing capacity

⚠ WARNING:

DO NOT overload the generator

Exceeding the capacity of generator can damage the generator and/or electrical devices connected to it.

- You must make sure your generator can supply enough rated (running) and surge (starting) watts for the electrical devices you will power at the same time. Follow these simple steps to calculate the running and starting watts necessary for your purposes.
 - Select the electrical devices you will power at the same time.
 - The amount of power you need to run all the devices is the total rated (running) watts of these items.
 - Identify how many surge (starting) watts you will need. Surge wattage is the short burst of power needed to start electric motor-driven tools or appliances such as a circular saw or refrigerator.
- Because not all motors start at the same time, total surge watts can be estimated by adding only the electrical device(s) with the highest additional surge watts to the total rated watts from step 2.

⚠ WARNING:

You must isolate the generator from electric utility by opening the electrical system's main circuit breaker or main switch if the generator is used for backup power. Failure to isolate the generator from the power utility may result in injury or death to electric utility workers and damage to the generator due to backfeed of electrical energy.

Stopping the generator

- Remove all loads on generator.
- Remove the plugs of all electric equipment from the generator panel.

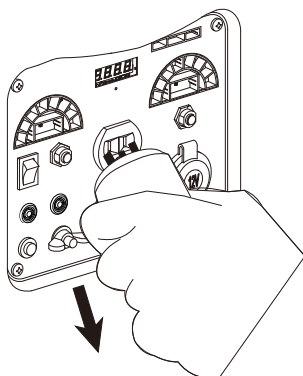

⚠ WARNING:

NEVER stop the engine with electrical devices connected and with the connected devices turned "ON".

- Turn the energy saving switch to the "ON" position.

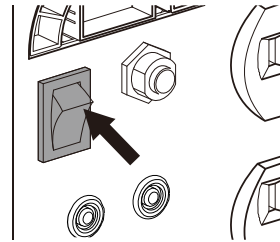

- Allow the generator run at no load for a few minutes to stabilize internal temperatures of the engine and generator.
- Turn the ON/OFF dial to the OFF position.

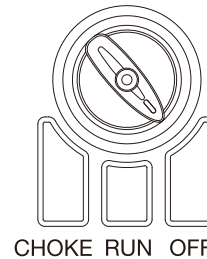

Parallel operation (If applicable)

Make sure that the generator is in a good running state before connecting it to other generators. The total power of electric devices should not exceed rated power of generator.

When electric motor starts, the overload indicator (red) will light up and normally it will stop within 4 seconds. If it cannot stop, please consult your local dealer.

During parallel operation, energy-saving switches of generators should be in the same position.

- Connect one generator to other generator(s) in parallel. Use the provided parallel kit to make the parallel connection (the parallel kit needs to be purchased separately).
- Start the engine in proper order and make sure that the running indicator (green) is normal.
- Connect the plug of electric devices to the AC receptacle of parallel kit.
- Run the electric devices.

⚠ CAUTION:

When overload too much, overload indicator (red) blinks continuously, and the generator may be damaged. When overload a little, overload indicator (red) lights up continuously, it may shorten the service life of generator.

When continuously operating the generator, power cannot exceed the rated power of generator.

The total power of electric devices cannot exceed the rated power of generator. The manufacturers of electric devices or tools always list the rated power of similar models or serial number.

MAINTENANCE

A repair shop or person of the owner's choosing may maintain, replace or repair emission control devices and systems; however, warranty replacements or repairs must be performed by an FNA distribution or service center. To obtain information about how to make a warranty claim or to make arrangements for authorized repairs, please contact FNA Group at cservice@fna-group.com or 1-877-362-4271.

It is the owner's/operator's responsibility to complete all scheduled maintenance in a timely manner. Correct any issue before operating the engine. Always follow the inspection and maintenance recommendations and schedules in this manual. Before servicing the generator, **stop the generator**, disconnect all electrical devices and battery(if equipped) and allow the generator to cool down.

⚠ WARNING:

Improper maintenance or failure to correct a problem before operation can cause a malfunction and result in property damage, serious injury or DEATH.
Improper maintenance may void your warranty.



⚠ DANGER:

Accidental starts can cause severe injury or death. Remove and ground spark plug wire before performing any service.

⚠ CAUTION:

The filter element may contain polyaromatic hydrocarbons (PAHs). PAHs are harmful to your health. Please wear gloves for protection during air filter maintenance.

Maintenance Schedule

Follow the service intervals indicated in the chart below. Your generating set may need to be serviced more frequently when operating in adverse conditions, such as excessive dust or airborne debris, high moisture, high vibrations, or intense heat or sunlight.

		Each time before use	The first month or 10 hours ^{Note 2}	Every three months or 50 hours ^{Note 2}	Every six months or 100 hours ^{Note 2}	Every year or 300 hours ^{Note 2}
Engine oil	Inspection	√				
	Replacement		√	√		
Air cleaner	Inspection	√				
	Cleaning			√ ^{Note 3}		
Spark plug	Inspection and adjustment				√	
	Replacement					√
Spark extinguisher ^{Note 1}	Cleaning				√	
Idle speed	Inspection and adjustment					√ ^{Note 4}
Valve clearance	Inspection and adjustment					√ ^{Note 5}
Carbon canister ^{Note 1}	Inspection	Every two years ^{Note 4}				
Low permeability oil tube ^{Note 1}	Inspection	Every two years ^{Note 4}				
Oil tube	Inspection	Every two years ^{Note 4}				

Note 1: Applicable types.

Note 2: Before each season and after then (whichever comes first).

Note 3: Service more frequently under severe, dusty, dirty conditions.

Note 4: To be performed by knowledgeable, experienced owners or the authorized dealer.

Note 5: To be performed by knowledgeable, experienced owners or the authorized dealer, but not necessary to keep the emission control warranty valid.

Generator maintenance

- Make certain that the generator is kept clean and stored properly.
- Use a damp cloth to clean exterior surfaces of the generator.
- Use an air compressor (25 PSI) to clear dirt and debris from the generator.
- Inspect all air vents and cooling slots to ensure that they are clean and unobstructed.

⚠ WARNING:

DO NOT use water to clean the generator. Water can enter the generator through the cooling slots and damage the generator windings.

⚠ WARNING:

DO NOT modify the generator in any way.
DO NOT tamper with governed speed. Generating set supplies correct rated frequency and voltage when running at factory. Tampering with the factory set governor will void your warranty.

Engine Maintenance

Engine Oil

SAE 10W-30 is recommended for general, all-temperature use. Other viscosities shown in the chart may be used when the average temperature in your area is within the indicated range.

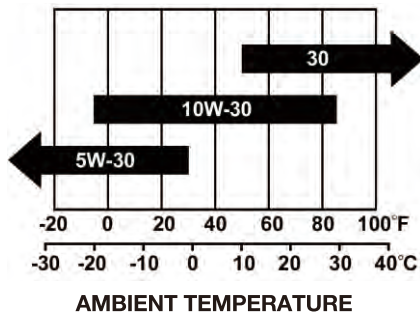

See **SPECIFICATIONS** for oil capacity (rated)

Add Oil

1. Place the engine on a level surface.
2. Remove the dipstick and wipe it clean.

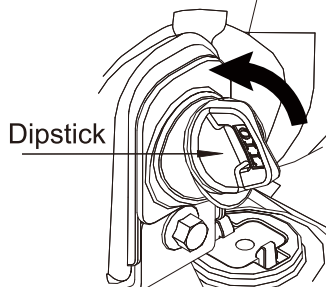

3. Add recommended oil to the upper limit.

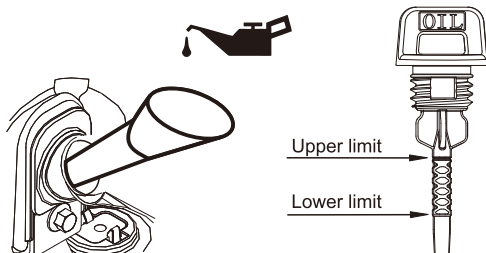

⚠ CAUTION:

Oil level check

Reinstall dipstick into hole; rest on oil fill neck. **DO NOT** thread cap into hole.

4. Fully tighten the dipstick.
5. Properly dispose of any used oil at an approved waste management facility.

Change Oil

⚠ CAUTION:

Change oil when the engine is warm from operation.

1. Place the engine on a level surface which is 300mm higher than the ground.
2. Remove the appearance cover.

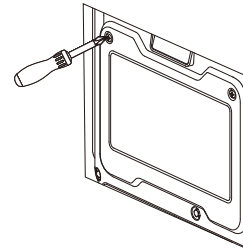

3. Place the waste oil box on the ground.
4. Remove oil dipstick, and tilt the machine to pour the oil.

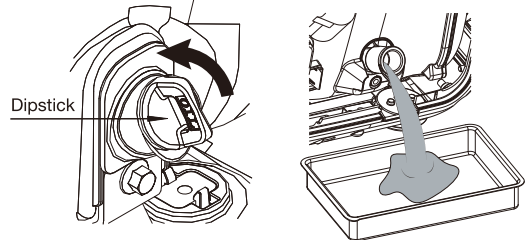

5. Add recommended oil to the upper limit.
6. Reinstall and fully tighten the dipstick.
7. Dispose of used oil at an approved waste management facility.
8. Reinstall the appearance cover.

Spark Plug

1. Clean any dirt from the spark plug cap and spark plug base.
2. Remove the spark plug cap.
3. Use a socket wrench to loosen and remove the spark plug.
4. Inspect the spark plug and spark plug washer. If they are damaged or worn, replace with a new one. Clean the spark plug with a wire brush if it can be reused.

NOTICE: Replace spark plug if electrodes are pitted, burned or porcelain is cracked. Use only the recommended spark (Champion RN9YC or equivalent). The use of a nonrecommended spark plug can result in damage to the engine.

5. Check spark plug gap. Carefully bend side electrode to adjust the gap if necessary. **Spark plug gap: 0.6mm - 0.8mm**

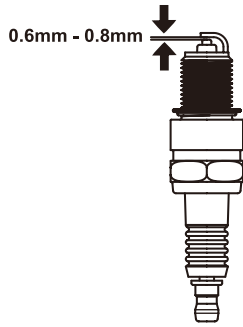

6. Carefully thread the plug into the engine by hand.
7. After the spark plug is seated, use spark plug wrench to tighten the plug. **Spark Plug Torque: 20-25N.m**
8. Attach the spark plug cap to the plug.

⚠ WARNING:

Only use recommended spark plug or equivalent. DO NOT use spark plugs that have improper heat range.

Spark Arrester

(Applicable types)

1. Allow the engine to cool completely before servicing the spark arrester.
2. Remove the muffler blind window.
3. Remove the spark arrester screen.
4. Carefully remove the carbon deposits from the spark arrester screen with a wire brush.
5. Replace the spark arrester if it is damaged.
6. Reinstall the spark arrester in the muffler and reinstall the muffler blind window.

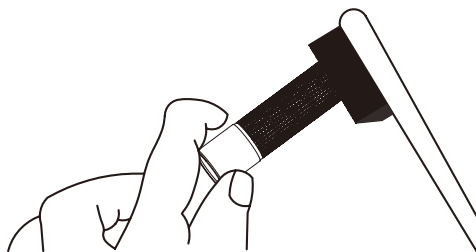

Clean carbon deposits

7. Fully tighten the dipstick.
8. Properly dispose of any used oil at an approved waste management facility.
9. Reinstall the oil maintenance cover.

⚠ WARNING:

The engine is not filled with oil at the factory. Any operation before it has been properly filled with the recommended type and amount of oil may result in engine damage and void your warranty.

Air Filter

1. Remove the appearance cover.
2. Remove the cover of the air filter.
3. Remove the foam filter element.
4. Wash in liquid detergent and warm water.
5. Squeeze thoroughly dry in a clean cloth.
6. Saturate in clean engine oil.
7. Squeeze in a clean absorbent cloth to remove all excess oil.
8. Place the filter in the assembly.
9. Mounting it back to the air filter body.
10. Reinstall the appearance cover.

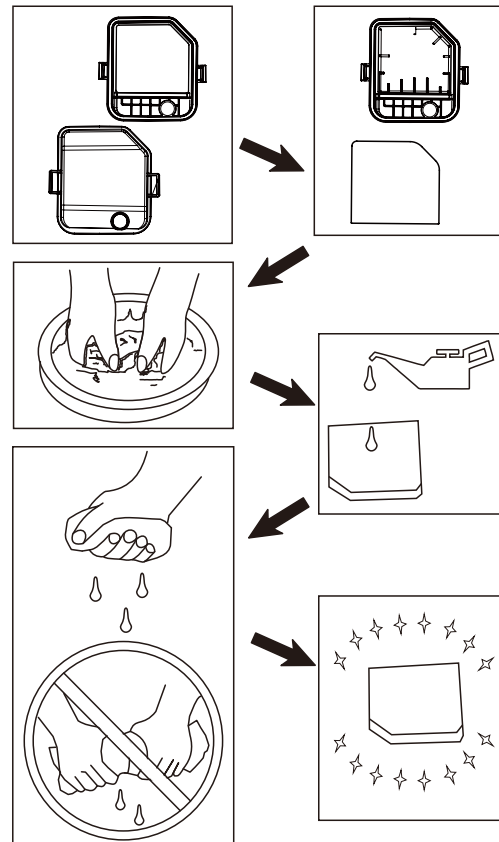

⚠ WARNING:

DO NOT run the engine without the air filter. Serious damage to the engine can result without the air filter.

TROUBLE ANALYSIS AND TROUBLESHOOTING

Failure	Trouble	Solution
Generator fails to start	ON/OFF dial is in "OFF" position.	Turn the ON/OFF dial to the "RUN" position.
	Lack of fuel.	Fill fuel tank per instructions in this manual.
	Lack of engine oil.	Check oil level. This engine is equipped with a low oil sensor. The engine cannot be started unless the oil level is above the prescribed lower limit.
	No ignition.	Remove the spark plug cap. Clean any dirt around the plug base, and then remove the spark plug. Install the spark plug in the plug cap. Turn the two-in-one switch to "RUN" position. Grounding the electrode to any engine ground, pull the recoil starter to see if sparks jump across the gap. If there is no spark, replace the plug. Reinstall the plug and start engine according to instructions in this manual. Consult Customer Service if necessary.
	Spark plug is splashed by fuel	Remove the spark plug and wipe the fuel.
	The generator flames out after running for a certain time.	Turn the ventilation knob on the fuel tank cap to "ON" position; Check the fuel and oil level. Add them if necessary.
Generator has no output	Breaker trip	Reset circuit breakers.
	Inadequate cord sets or extension cords.	Check cord sets or extension cords capabilities in section controls; cable size in this manual. Consult Customer Service if necessary.

STORAGE AND TRANSPORTATION

Storage

The generator should be started at least once every two weeks and allowed to run for at least 20 minutes. Follow the instructions below for longer term storage if the generating set will be out of service for 2 months or more.



⚠ DANGER:

FIRE OR EXPLOSION

Gasoline is highly flammable and extremely explosive. Empty the fuel tank before storing or transporting the generator.

1. Allow the generator to cool completely before storage.
2. Clean the generator according to the instructions in the Maintenance section.
3. Drain all fuel completely from the fuel hose and carburetor to prevent gum from forming.
4. Turn off the fuel supply at the fuel valve.
5. Change the oil.
6. Reattach the spark plug.
7. Remove the spark plug and pour about 15ml of oil into the cylinder. Crank the engine slowly to distribute the oil and lubricate the cylinder.
8. Store the unit in a clean, dry area out of direct sunlight.

Transportation

To prevent fuel spillage when transporting or during temporary storage, the generating set should be secured upright in its normal operating position, with the engine switch OFF. The fuel valve lever should be turned OFF.

⚠ WARNING:

When transporting:

DO NOT overfill the tank.
DO NOT operate the generator while it is on vehicle. Take the generator off the vehicle and use it in a well-ventilated place. Avoid a place exposed to direct sunlight when putting the generator on a vehicle. If the generator is left in an enclosed vehicle for many hours, high temperature inside the vehicle could cause fuel to vaporize resulting in a possible explosion.
DO NOT drive on a rough road for an extended period with the generator on board. If you must transport the generator on a rough road, drain the fuel from the generator beforehand.

SPECIFICATIONS

Specification Parameter Table

Feature	Model	SIG2218
Engine parameter	Engine model	148FD/P
	Style	OHV
	Displacement (cm ³)	79
	Ignition system	CDI
	Start style	Hand recoil starting
	Oil capacity(L)	0.5
Series parameter	Frequency(Hz)	60
	Voltage(V)	120
	Rated power(kW)	1.8
	Maximum power(kW)	2.2
	Power factor	1.0
	Insulation rate	F
	Fuel capacity(L)	5
	Max. site ambient temperature(°C)	40
	Max. site altitude of installation(m)	1500
	Measured sound pressure level(dB(A))	≤68
	Measurement uncertainty(dB(A))	≤1.5
	Guaranteed sound power level(dB(A))	≤88
Net weight(kg)	199	

Wiring Diagram for 60Hz

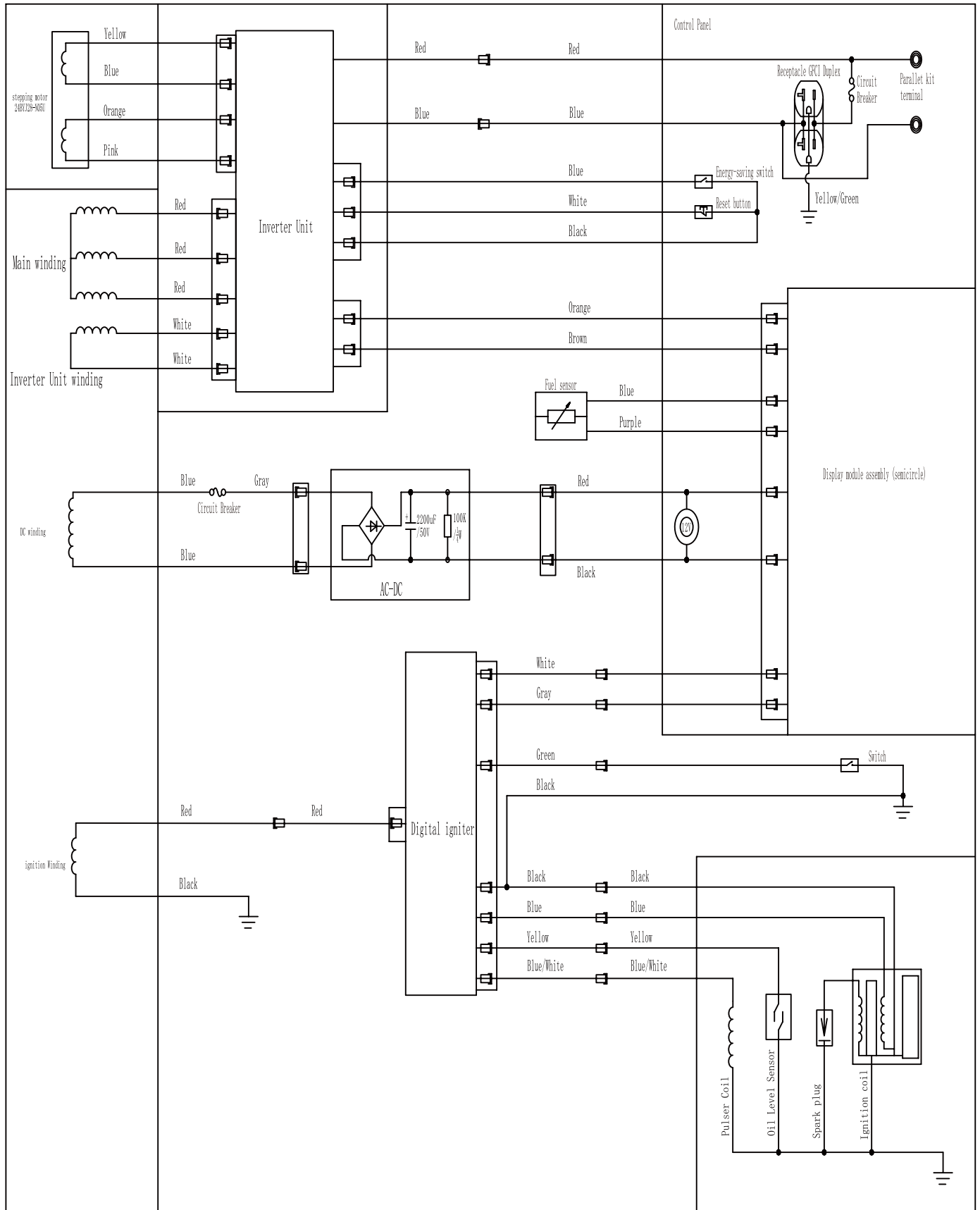

NOTE: Because of the difference of generator, the wiring diagram is only for reference.

LIMITED WARRANTY

FNA Group, warrants to the original retail purchaser that this SIMPSON brand outdoor product is free from defect in material and workmanship and agrees to repair or replace, at FNA Group's, discretion, any defective product free of charge within these time periods from the date of purchase.

Three years if the product is used for personal, family or household use;

This warranty extends to the original retail purchaser only and commences on the date of the original retail purchase.

Any part of this product found in the reasonable judgment of FNA Group to be defective in material or workmanship will be repaired or replaced without charge for parts and labor by an authorized service center for SIMPSON brand outdoor products. (Authorized SIMPSON Service Center).

The product, including any defective part, must be returned to an authorized SIMPSON service center within the warranty period. The expense of delivering the product to the service center for warranty work and the expense of returning it back to the owner after repair or replacement will be paid by the owner. SIMPSON's responsibility in respect to claims is limited to making the required repairs or replacements and no claim of breach of warranty shall be cause for cancellation or rescission of the contract of sale of any SIMPSON brand outdoor product. Proof of purchase will be required by the dealer to substantiate any warranty claim. All warranty work must be performed by an authorized service center.

This warranty does not cover any product used for rental or commercial purposes, or any other income-producing purpose

This warranty does not cover any product that has been subject to abuse, misuse, neglect, negligence, accident, the effects of corrosion or erosion, or that has been operated in any way contrary to the operating instructions as specified in this operator's manual. This warranty does not apply to any damage to the product that is the result of improper maintenance or to any product that has been altered or modified. The warranty does not extend to repairs made necessary by normal wear or by the use of parts or accessories which are either incompatible with the SIMPSON brand outdoor product or adversely affect its operation, performance, or durability.

In addition, this warranty does not cover:

Tune-ups – Spark Plugs, Carburetor, Carburetor Adjustments, Ignition, Filters, Oil Change

Wear items—Recoil Starter Rope, Motor Brushes, Alternator Brushes, Cotter Pins, Wheels, a High Pressure Hose, Spray Wand, Nozzles, Trigger Handle, Supply Hoses, Quick Couplers, Gaskets, Valves, Pistons, Pump Valve Assemblies, O-Rings, Water and Oil Seals, Detergent Tanks.

ALL IMPLIED WARRANTIES ARE LIMITED IN DURATION TO THE STATED WARRANTY PERIOD. ACCORDINGLY, ANY SUCH IMPLIED WARRANTIES INCLUDING MERCHANTABILITY, FITNESS FOR A PARTICULAR PURPOSE, OR OTHERWISE, ARE DISCLAIMED IN THEIR ENTIRETY AFTER THE EXPIRATION OF THE APPROPRIATE THREE-YEAR OR NINETY-DAY WARRANTY PERIOD.

SIMPSON OBLIGATION UNDER THIS WARRANTY IS STRICTLY AND EXCLUSIVELY LIMITED TO THE REPAIR OR REPLACEMENT OF DEFECTIVE PARTS AND SIMPSON DOES NOT ASSUME OR AUTHORIZE ANYONE TO ASSUME FOR THEM ANY OTHER OBLIGATION. SOME STATES DO NOT ALLOW LIMITATIONS ON HOW LONG AN IMPLIED WARRANTY LASTS, SO THE ABOVE LIMITATION MAY NOT APPLY TO YOU. SIMPSON ASSUMES NO RESPONSIBILITY FOR INCIDENTAL,

CONSEQUENTIAL, OR OTHER DAMAGES INCLUDING, BUT NOT LIMITED TO, EXPENSE OF RETURNING THE PRODUCT TO AN AUTHORIZED SIMPSON SERVICE CENTER AND EXPENSE OF DELIVERING IT BACK TO THE OWNER, MECHANIC'S TRAVEL TIME, TELEPHONE OR TELEGRAM CHARGES, RENTAL OF A LIKE PRODUCT DURING THE TIME WARRANTY SERVICE IS BEING PERFORMED, TRAVEL, LOSS OR DAMAGE TO

PERSONAL PROPERTY, LOSS OF REVENUE, LOSS OF USE OF THE PRODUCT, LOSS OF TIME, OR INCONVENIENCE. SOME STATES DO NOT ALLOW THE EXCLUSION OR LIMITATION OF INCIDENTAL OR CONSEQUENTIAL DAMAGES, SO THE ABOVE LIMITATION OR EXCLUSION MAY NOT APPLY TO YOU.

This warranty gives you specific legal rights, and you may also have other rights which vary from state to state. This warranty applies this SIMPSON brand outdoor product manufactured by or for SIMPSON's and sold in the United States and Canada.

To locate your nearest Authorized SIMPSON Service Center, dial 1-877-362-4271.

Emission Control System Warranty

FEDERAL and CALIFORNIA EMISSION CONTROL WARRANTY STATEMENT

YOUR WARRANTY RIGHTS AND OBLIGATIONS

FNA Group (FNA), the United States Environmental Protection Agency (EPA), and the California Air Resources Board (CARB) are pleased to explain the emission control system (ECS) warranty on your 2018 small off-road spark-ignited engine and equipment (the outdoor equipment). In California, new outdoor equipment must be designed, built and equipped to meet the State's stringent anti-smog standards (in other states, outdoor equipment must be designed, built, and equipped to meet the U.S. EPA small off-road, spark ignition engine regulations). FNA must warrant the ECS on your outdoor equipment for the period of time listed below provided there has been no abuse, neglect or improper maintenance of outdoor equipment.

Your ECS may include parts such as the carburetor, fuel-injection system, ignition system, catalytic converter, fuel tanks, fuel lines, fuel caps, valves, canisters, filters, vapor hoses, clamps, connectors and other associated emission-related components. For engines less than or equal to 80cc only the fuel tank is subject to the evaporative emission control warranty requirements of this section (California only).

Where a warrantable condition exists, FNA will repair your outdoor equipment at no cost to you including diagnosis, parts and labor.

MANUFACTURER'S WARRANTY COVERAGE:

This emission control system is warranted for two years. If any emission-related part on your outdoor equipment is defective, the part will be repaired or replaced by FNA.

OWNER'S WARRANTY RESPONSIBILITIES:

As the outdoor equipment owner, you are responsible for performance of the required maintenance listed in your owner's manual. FNA recommends that you retain all receipts covering maintenance on your outdoor equipment, but FNA cannot deny warranty solely for the lack of receipts or your failure to ensure the performance of all scheduled maintenance.

As the outdoor equipment owner, you should however be aware that FNA may deny you warranty coverage if your outdoor equipment or a part has failed due to abuse, neglect, or improper maintenance or unapproved modifications.

You are responsible for presenting your outdoor equipment to FNA's distribution center or service center as soon as the problem exists. The warranty repairs should be completed in a reasonable amount of time, not to exceed 30 days.

If you have any questions regarding your warranty rights and responsibilities, you should contact:

FNA Group
7152 99th Street, Pleasant Prairie, WI 53158
1-877-362-4271
cservice@fna-group.com

DEFECTS WARRANTY REQUIREMENTS

FNA warrants to the ultimate purchaser and each subsequent purchaser that the outdoor equipment is designed, built and equipped so as to conform with all applicable regulations; and free from defects in materials and workmanship that cause the failure of a warranted part, and is identical in all material respects to that part as described in the application for certification.

The warranty period begins on the date the outdoor equipment is delivered to an ultimate purchaser or first placed into service.

Subject to certain conditions and exclusions as stated below, the warranty on emission-related parts is as follows:

1. Any warranted part that is not scheduled for replacement as required maintenance in the written instructions supplied is warranted for the warranty period stated above. If the part fails during the period of warranty coverage, the part will be repaired or replaced by FNA according to subsection (4) below. Any such part repaired or replaced under warranty will be warranted for the remainder of the period.
2. Any warranted part that is scheduled only for regular inspection in the written instructions supplied is warranted for the warranty period stated above. Any such part repaired or replaced under warranty will be warranted for the remaining warranty period.
3. Any warranted part that is scheduled for replacement as required maintenance in the written instructions supplied is warranted for the period of time before the first scheduled replacement date for that part. If the part fails before the first scheduled replacement, the part will be repaired or replaced by FNA according to subsection (4) below. Any such part repaired or replaced under warranty will be warranted for the remainder of the period prior to the first scheduled replacement point for the part.
4. Repair or replacement of any warranted part under the warranty provisions herein must be performed at a warranty station at no charge to the owner.
5. Notwithstanding the provisions herein, warranty services or repairs will be provided at all of our distribution centers that are franchised to service the subject engines or equipment.
6. The outdoor equipment owner will not be charged for diagnostic labor that is directly associated with diagnosis of a defective, emission-related warranted part, provided that such diagnostic work is performed at a warranty station.
7. FNA is liable for damages to other engine or equipment components proximately caused by a failure under warranty of any warranted part.
8. Throughout the outdoor engine and equipment warranty period stated above, FNA will maintain a supply of warranted parts sufficient to meet the expected demand for such parts.
9. Any replacement part may be used in the performance of any warranty maintenance or repairs and must be provided without charge to the owner. Such use will not reduce the warranty obligations of FNA.
10. Add-on or modified parts that are not exempted by the Air Resources Board may not be used. The use of any non-exempted add-on or modified parts by the ultimate purchaser will be grounds for disallowing a warranty claim. FNA will not be liable to warrant failures of warranted parts caused by the use of a non-exempted add-on or modified part.

WARRANTED PARTS

The repair or replacement of any warranted part otherwise eligible for warranty coverage may be excluded from such warranty coverage if FNA demonstrates that the outdoor equipment has been abused, neglected, or improperly maintained, and that such abuse, neglect, or improper maintenance was the direct cause of the need for repair or replacement of the part. That notwithstanding, any adjustment of a component that has a factory installed, and properly operating, adjustment limiting device is still eligible for warranty coverage. Further, the coverage under this warranty extends only to parts that were present on the outdoor equipment purchased.

The following emission warranty parts are covered (if applicable):

(1) Fuel Metering System

- Cold start enrichment system (soft choke)
- Carburetor and internal parts (or fuel injection system)
- Fuel pump
- Fuel tank

(2) Air Induction System

- Air cleaner
- Intake manifold

(3) Ignition System

- Spark plug(s)
- Magneto ignition system

(4) Exhaust System

- Catalytic converter
- SAI (Reed valve)

(5) Miscellaneous Items Used in Above System

- Vacuum, temperature, position, time sensitive valves and switches
- Connectors and assemblies

(6) Evaporative Control

- Fuel hose
- Fuel hose clamps
- Tethered fuel cap
- Carbon canister
- Vapor lines

FNA Group
7152 99th Street,
Pleasant Prairie, WI 53158
1-877-362-4271
cservice@fna-group.com

1404#